

Peg-Pérego

FIUS1001G96

CE

EN

USE AND CARE

ES

EMPLEO Y MANUTENCION

FR

UTILISATION ET ENTRETIEN

See separate insert
sheet for more
information



Vea la hoja separada del
separador de millares
para más información

Voir la feuille séparée
d'insertion pour plus
d'information

2 YEARS*

*CONSUMER PARTICIPATION
REQUIRED

Requires 2 AA batteries (not included)
Requerir 2 AA baterías (no inclusa)
Exige 2 batteries de AA (ne pas inclus)

24V



GAUCHO SUPERPOWER

Model Number IGOD0501US

SEE VERBAL
INSTRUCTIONS AFTER
THE PICTURES

VER LAS INSTRUCCIONES
DESPUES DE LOS DISEÑOS

VOIR LES INSTRUCTIONS
APRES LES DESSINS

ASSEMBLY

MONTAJE

MONTAGE

1

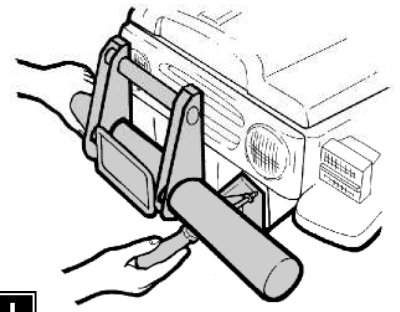

2

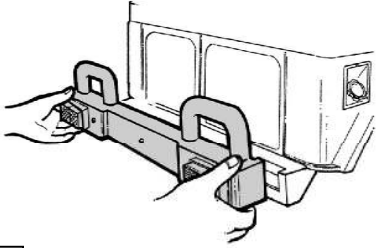

3

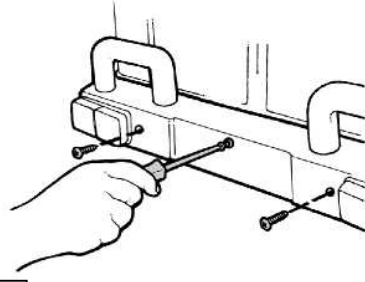

4

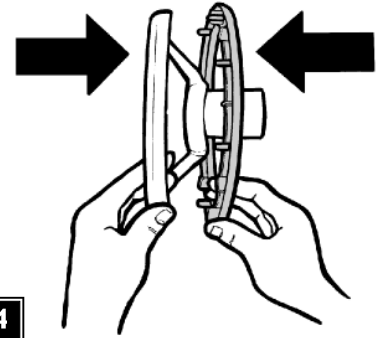

5

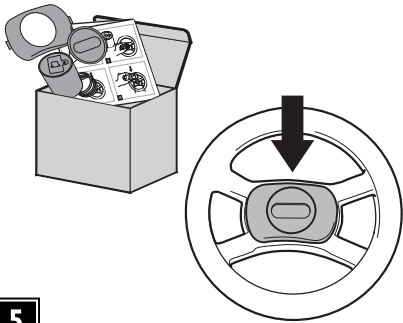

6

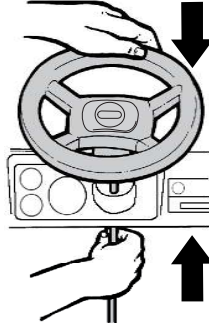

7

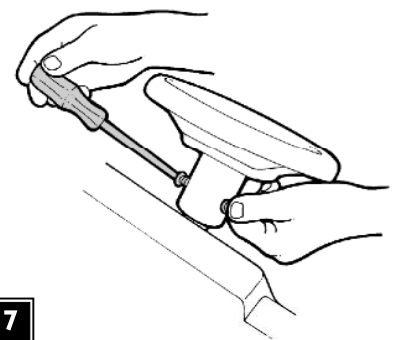

8

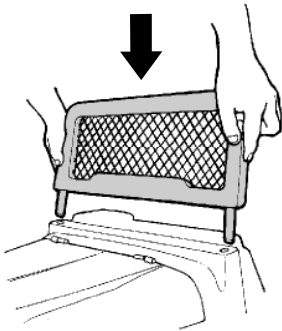

9

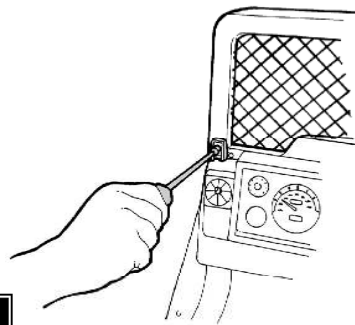

10

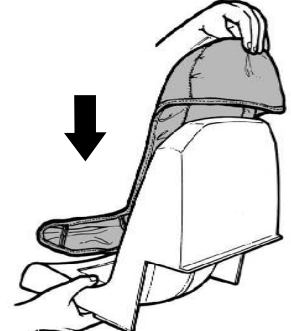

11



12

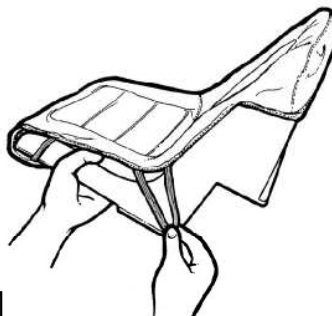

13

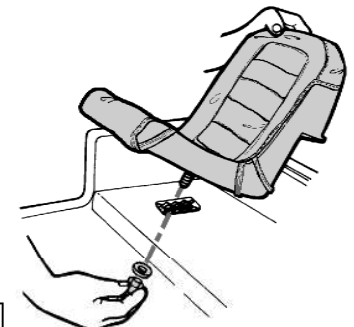

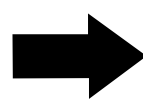
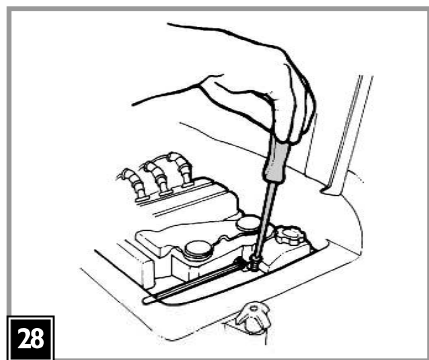
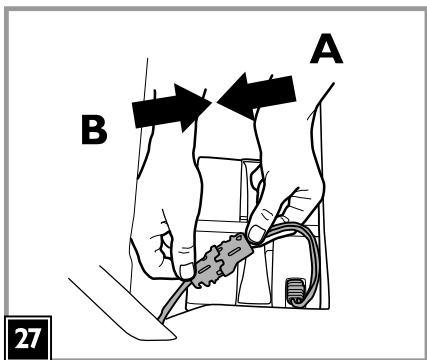
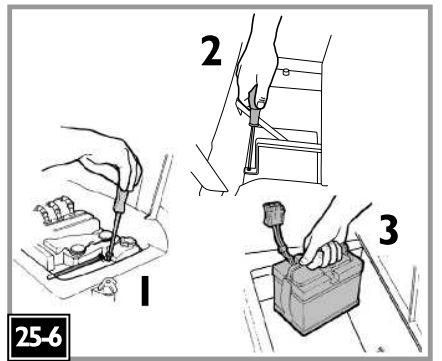
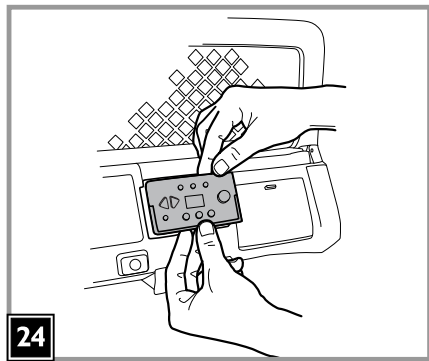
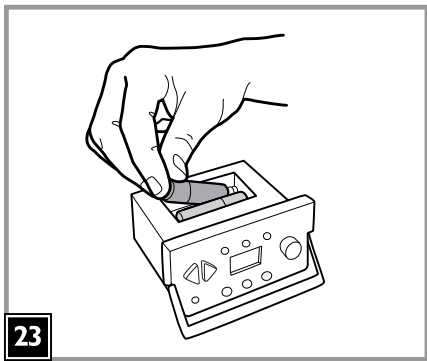
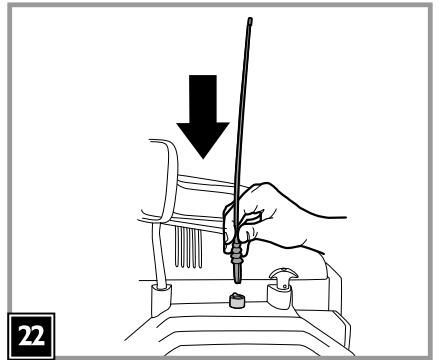
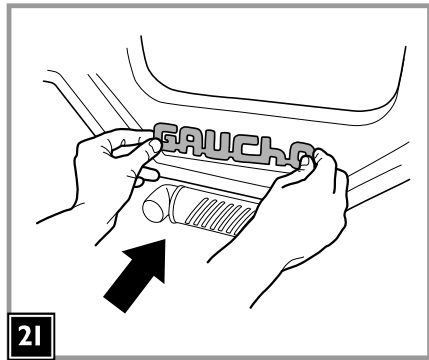
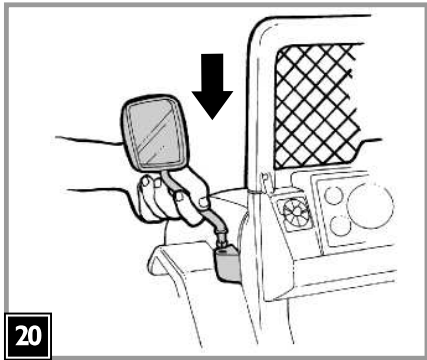
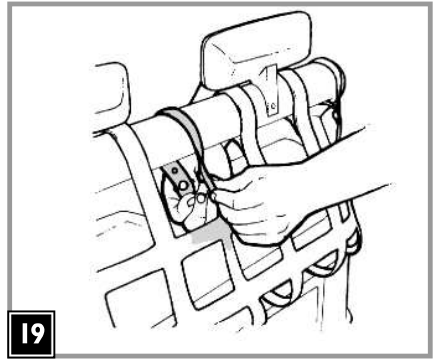
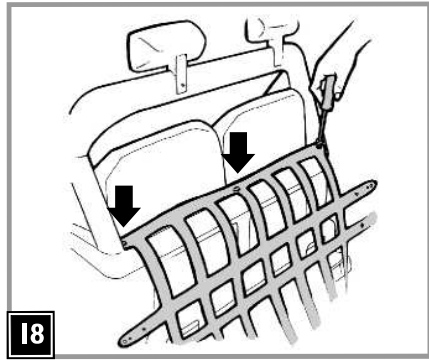
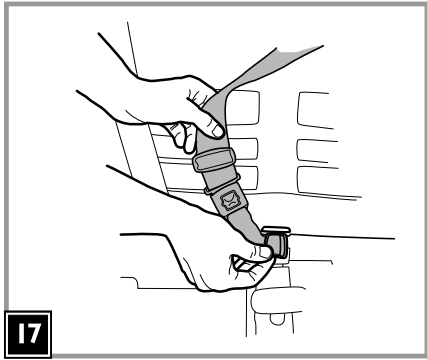
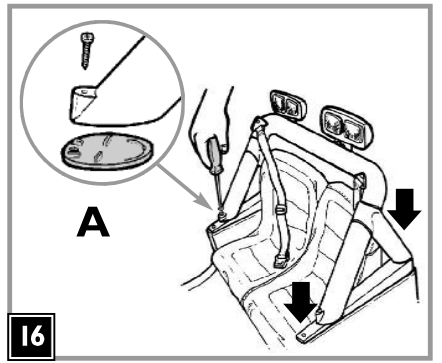
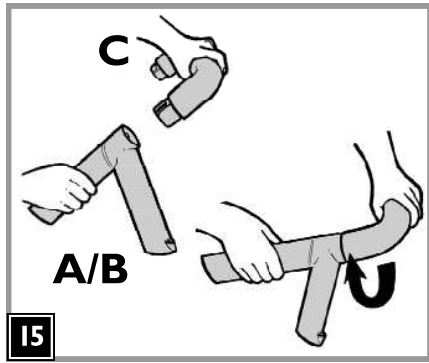
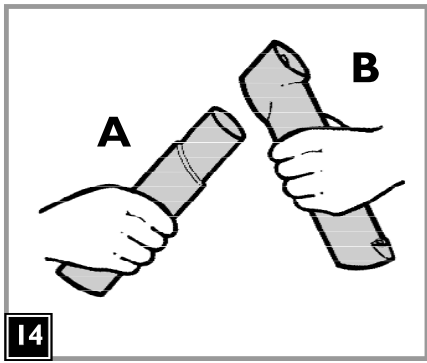

VEHICLE FEATURES AND INSTRUCTIONS FOR USE

CARACTERÍSTICAS Y USO DEL VEHÍCULO

CARACTÉRISTIQUES ET UTILISATION DU VEHICULE

29

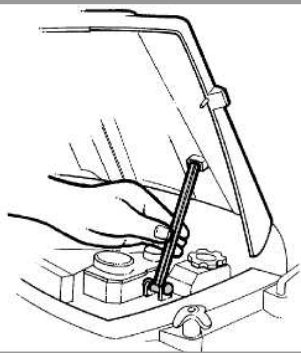

30

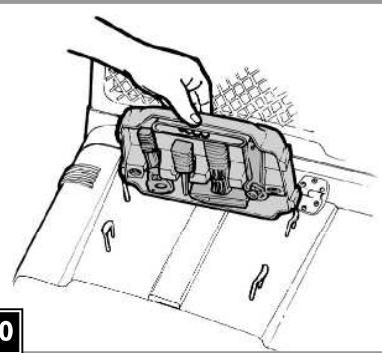

31

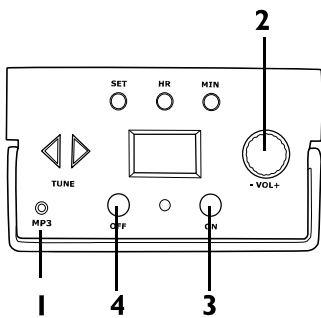
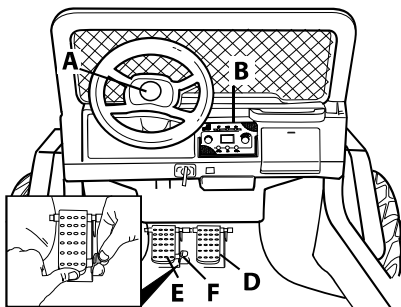

32

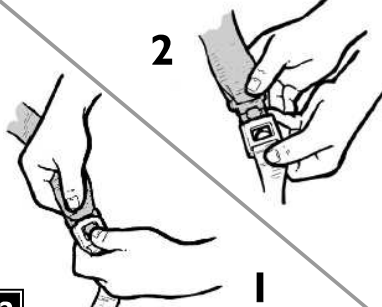

33

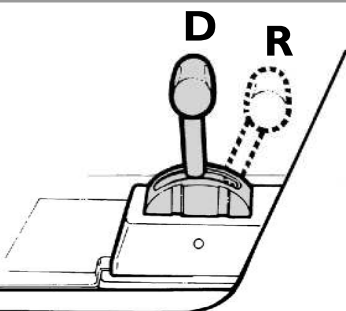

PARENTAL SPEED CONTROL
CONTRÔLE PARENTAL DE LA VITESSE
CONTROL DE VELOCIDAD PATERNO

34

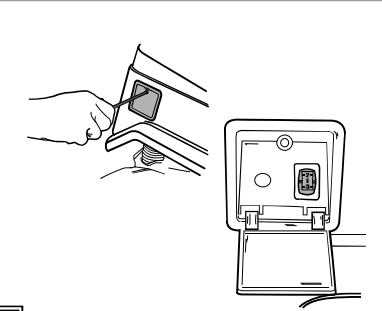

35

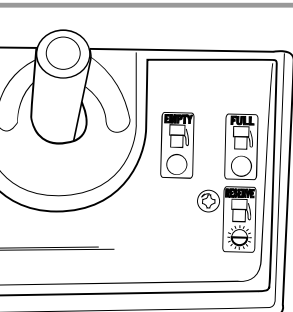

REGULATING REAR BRAKE
RÉGLAGE FREIN ARRIÈRE
REGULACIÓN DEL FRENO POSTERIOR

36

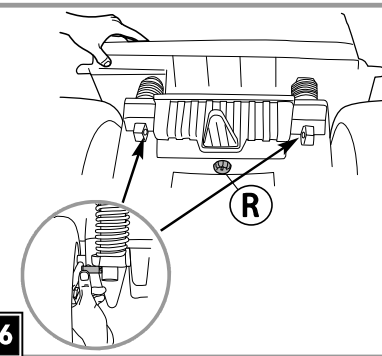

37

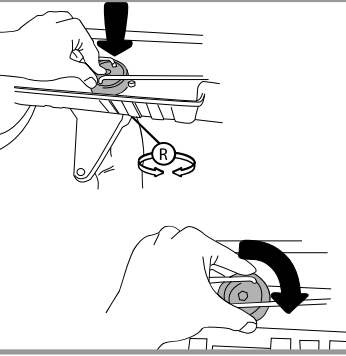

REPLACING THE BATTERY
CAMBIO DE LA BATERÍA
REPLACEMENT DE LA BATTERIE

38

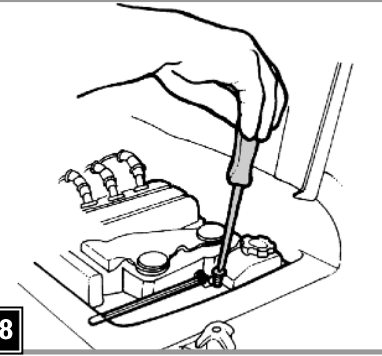

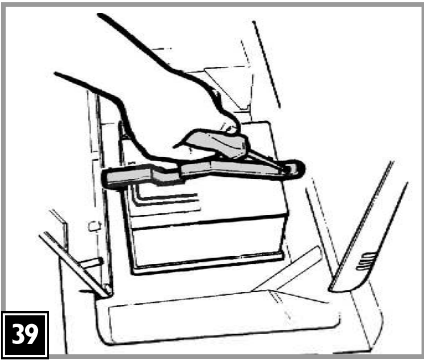

39

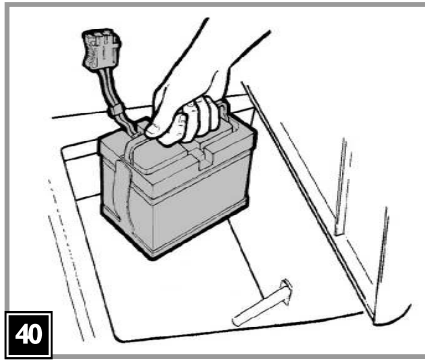

40

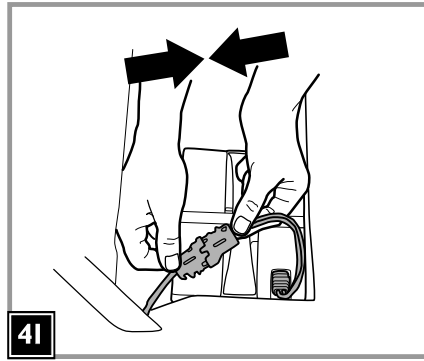

41

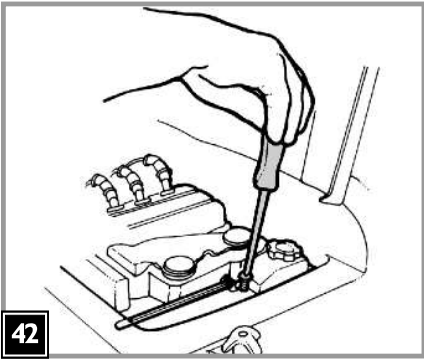

42

BATTERY CHARGING
CARGA DE LA BATERÍA
CHARGE DE LA BATTERIE

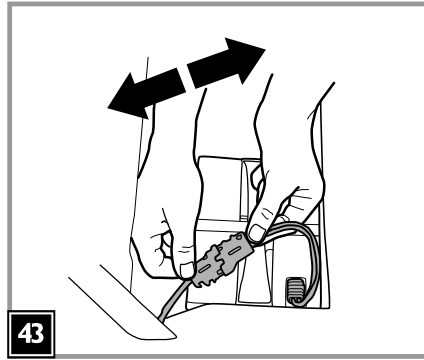

43

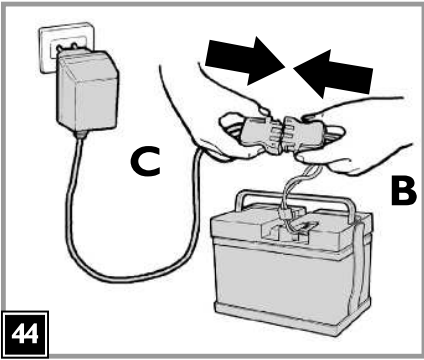

44

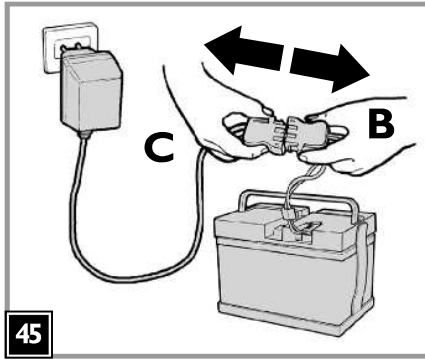

45

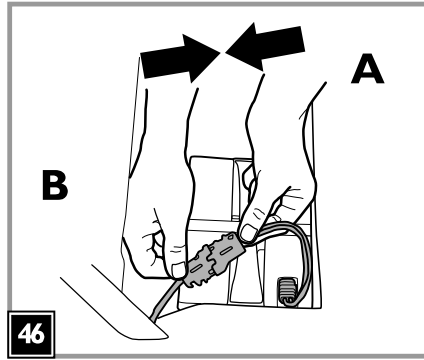

46

ELECTRICAL DIAGRAM DIAGRAMA ELÉCTRICO DIAGRAMME ÉLECTRIQUE **GAUCHO SUPERPOWER cod.IGMC0010US**

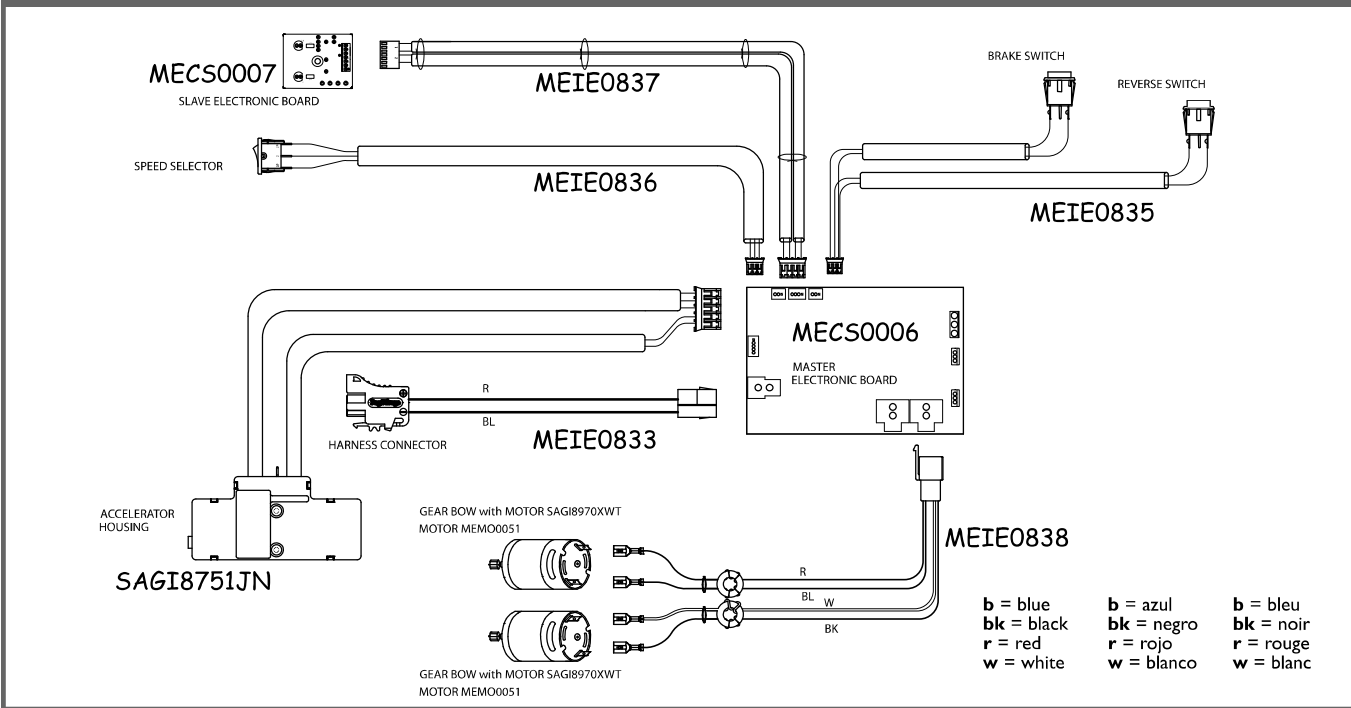

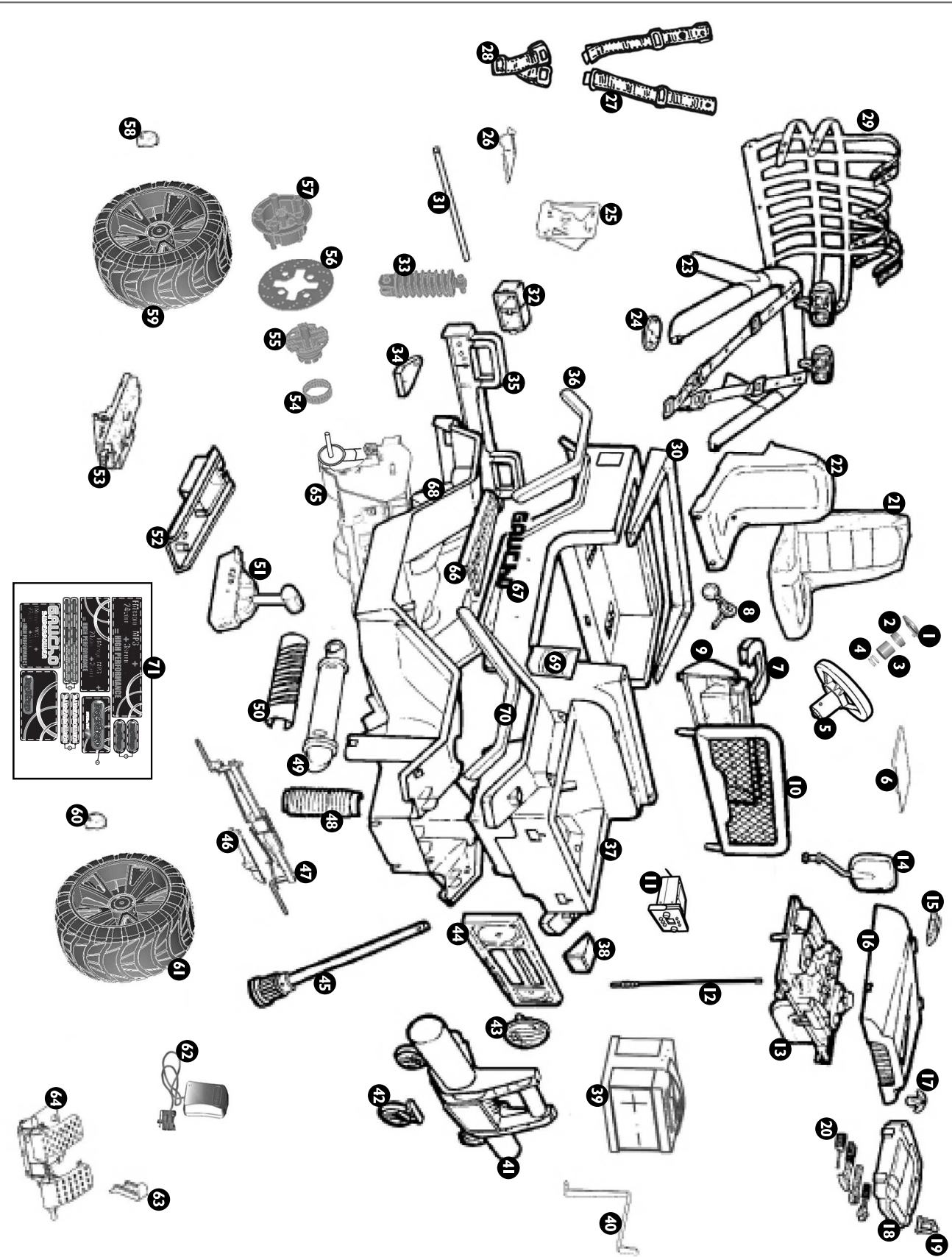

- | | |
|------|----------------|
| 1 | SFST9192N |
| 2 | SFST9193Y |
| 3 | SAG9192NY |
| 4 | MHHC00151 |
| 5 | ASG10217NGP |
| 6 | SFST8767N |
| 7 | SFST9452N |
| 8 | SAG10162N |
| 9 | SAG104451IGP |
| 10 | SAG3822KGP |
| 11 | MEVA0050 |
| 12 | SFST8235N |
| 13 | SAG3029GR |
| 14 | SAG10127DM |
| 15 | SAG10127SM |
| 15dx | ASG10054DN |
| 15sx | ASG10054SN |
| 16 | ASG10122NM |
| 17 | ASG10024GP |
| 18 | ASG10118GPR |
| 19 | SFST8210N |
| 20 | SAG10183GR |
| 21 | CSGALUC00-R153 |
| 22 | SAG10321N |
| 23 | ASG10043KGP |
| 24 | SFST3562N |
| 25 | SFST8749KN |
| 26 | SFST8750N |
| 27 | MUC11012GRN |
| 28 | MUC11009GR |
| 29 | SFST3867N |
| 30 | SFST3508N |
| 31 | SOFF0285Z |
| 32 | SFST3055A / RF |
| 33 | SAG18405KDNGR |
| 33sx | SAG18405KSNGR |
| 34 | SFST3552N |
| 35 | SAG10318KGP |
| 35dx | SFST3824DN |
| 36sx | SFST3825SN |
| 37 | SFST0315KN |
| 38 | ASG10053A |
| 39 | LAKB0021US |
| 40 | SOPF0054L30 |
| 41 | SAG12653GPA |
| 42 | ASG10135GPA |
| 43 | SFST0132 |
| 44 | SAG18821J9 |
| 45 | SAG10283L30 |
| 46 | SFST8741N |
| 47 | SAG18744KN |
| 48 | SFST3511R |
| 49dx | SFST3827DM |
| 49sx | SFST3827SM |
| 50dx | SFST3522DG |
| 50sx | SFST3522SGP |
| 51 | SAG18808KNGP |
| 52 | SFST3546N |
| 53 | SAG18751N |
| 54 | MHHC0035 |
| 55 | MHHC0035 |
| 56 | SONFH0050Z |
| 57 | SFST8936GL |
| 58 | SFST8812N |
| 59dx | SAG18878XDMN |
| 59sx | SAG18878XSMN |
| 60 | SFST8812N |
| 61dx | SAG18878XDMN |
| 61sx | SAG18878XSMN |
| 62 | KCCB0111 |
| 63 | SFST8766R |
| 64 | SAG18762NR |
| 65 | SAG13510KN |
| 66dx | SFST3507DG |
| 66sx | SFST3507SGP |
| 67 | SFST3053N |
| 68 | SFST1016KN |
| 69dx | SFST3833DM |
| 69sx | SFST3833SM |
| 70dx | SFST3823DN |
| 70sx | SFST3823SN |
| 71 | MHEV0720 |

